

TNC系列射频同轴连接器

概述

TNC系列射频同轴连接器采用螺纹锁紧，可抵抗恶劣冲击，特别适于中小射频功率传输的场合。安装快速、方便、连接可靠，其特性阻抗为50Ω。

TNC系列连接器符合GJB 681A-2002、MIL-C-39012和IEC 60169-17等标准。

主要技术特性

温度范围 Temperature range	-55℃~+155℃	绝缘电阻 Insulation resistance	≥5000MΩ
特性阻抗 Characteristic impedance	50Ω	介质耐压 Dielectric withstanding voltage	1500V
频率范围 Frequency range	0GHz~3GHz	电压驻波比 VSWR	≤1.35
工作电压 Voltage rating	500V		
接触电阻 Contact resistance	中心导体 Center conductor	寿命 Durability	500 Cycles
	外导体 Outer conductor		

头部配合尺寸 INTERFACE MATING DIMENSIONS

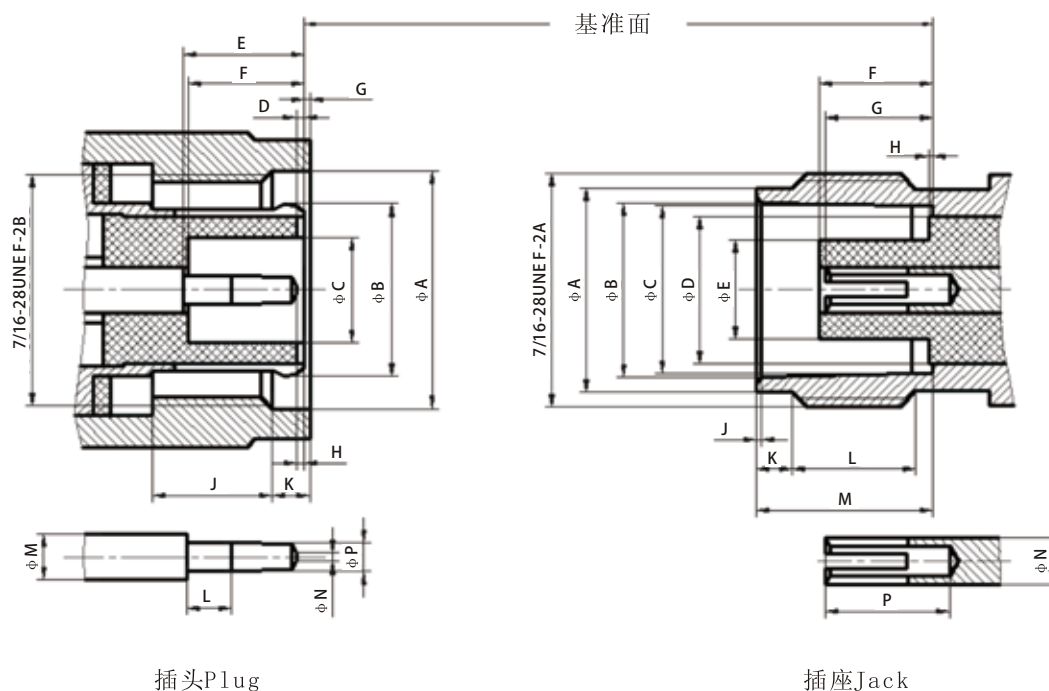

PLUG (mm)			JACK (mm)		
Symbol	MIN	MAX	Symbol	MIN	MAX
A	11.18	-	A	9.60	9.68
B	-	-	B	8.31	8.46
C	4.83	-	C	8.10	8.15
D	0.15	0.46	D	-	6.50
E	5.33	5.84	E	-	4.72
F	5.28	5.79	F	4.78	5.28
G	-	1.98	G	4.72	5.23
H	0.08	1.02	H	-	0.15
J	3.96	-	J	0.38	0.76
K	1.60	-	K	1.73	2.24
L	1.98	-	L	4.75	-
M	8.31	8.51	M	8.31	8.51
N	-	0.64	N	2.06	2.21
P	1.32	1.37	P	4.95	-

电缆连接器



TNC-JB2等

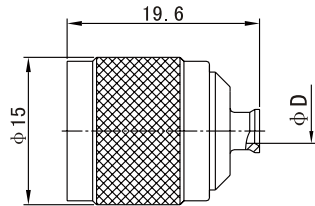

Type	D	Cable type
TNC-JB2	Φ2.2	SFT-50-2-1
TNC-JB3	Φ3.6	SFT-50-3-1



TNC-J5T

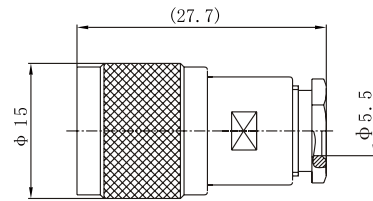

Type	Cable type
TNC-J5T	SYV-50-3



TNC-J27

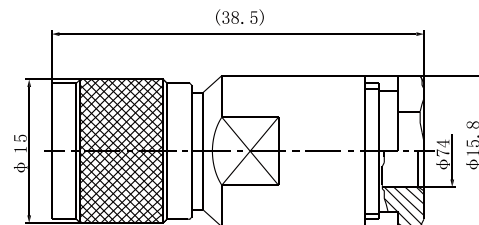

Type	Cable type
TNC-J27	SYV-50-5-1

TNC系列射频同轴连接器

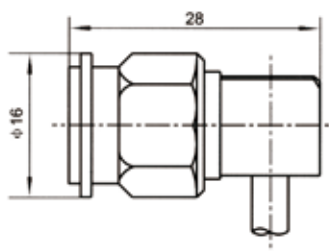

TNC-JWB3

Type	Cable type
TNC-JWB3	SFT-50-3-1

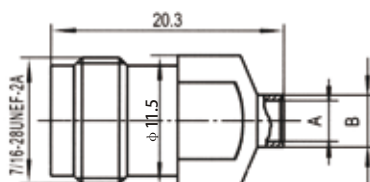

TNC-KB2等

Type	A	B	Cable type
TNC-KB2	φ 2.2	φ 3.0	SFT-50-2-1
TNC-KB3	φ 3.6	φ 4.6	SFT-50-3-1

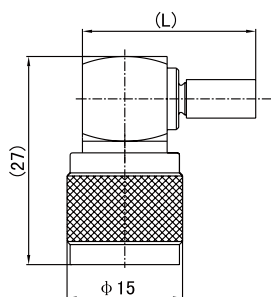

TNC-JW3Y等

Type	L	Cable type
TNC-JW3Y	22.5	SFF-50-1.5-1、SYV-50-2-1
TNC-JW4Y	22.5	SFF-50-2-2
TNC-JW5Y	23	SFF-50-3-1

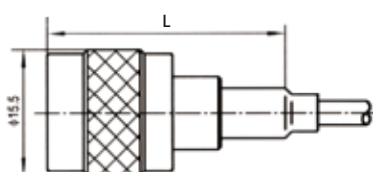

TNC-J3Y等

Type	L	Cable type
TNC-J3Y	27.3	SYV-50-2-1、SFF-50-1.5-1
TNC-J4Y	28	SYV-50-2-2、SFF-50-2-2
TNC-J5Y	29.7	SYV-50-3

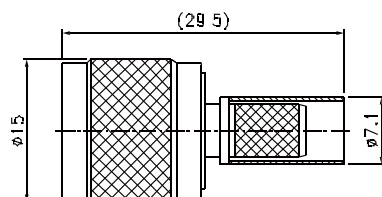

TNC-J240Y

Type	Cable type
TNC-J240Y	LMR-240/UF

TNC系列射频同轴连接器



TNC-J400Y

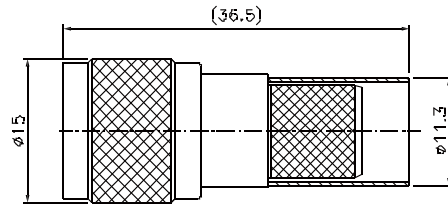

Type	Cable type
TNC-J400Y	LMR-400/UF



TNC-K3Y等

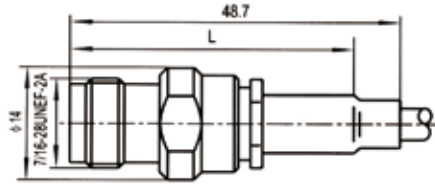

Type	L	Cable type
TNC-K3Y	33.7	SFF-50-1.5-1 SYV-50-2-1
TNC-K4Y	33.7	SFF-50-2-2 SYV-50-2-2
TNC-K5Y	33.4	SFF-50-3-1 SYV-50-3



TNC-KF3

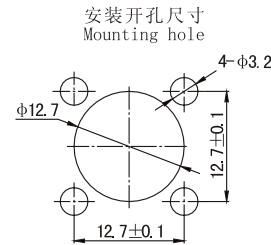
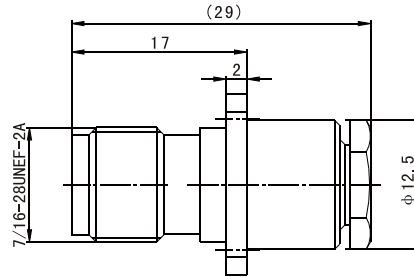

Type	Cable type
TNC-KF3	SYV-50-2-1 SFF-50-1.5-1



TNC(M)-KF3Y等

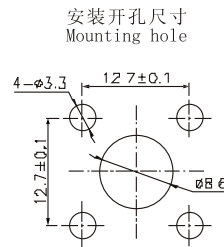
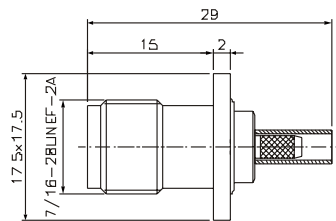

Type	Cable type
TNC(M)-KF3Y	SFF-50-1.5-1 RG316/U
TNC(M)-KF4Y	SFF-50-2-2 SYV-50-2-2



TNC(M)-50KYB2

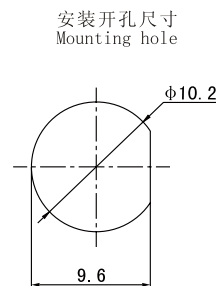
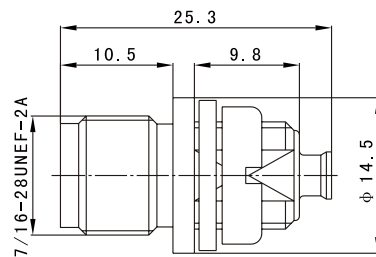

Type	Cable type
TNC(M)-50KYB2	SFT-50-2-1

TNC系列射频同轴连接器



TNC (M) -50KYB1. 5

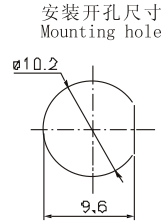
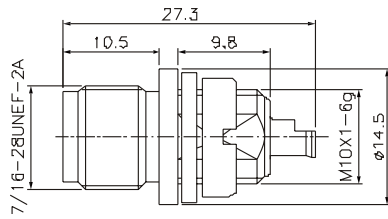

Type	Cable type
TNC (M) -50KYB1. 5	IPEX-1.37 IPEX-1.13



TNC (M) -50KYB1. 5A

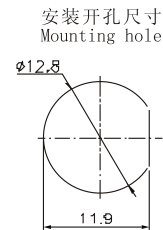
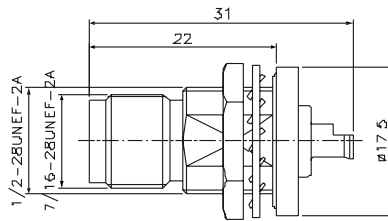

Type	Cable type
TNC (M) -50KYB1. 5A	IPEX-1.37 IPEX-1.13



TNC (M) -50KYB1. 5B

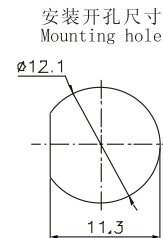
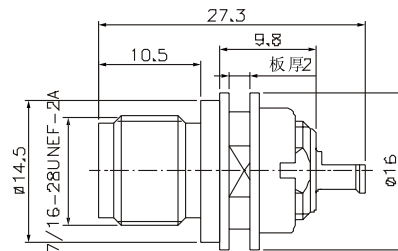

Type	Cable type
TNC (M) -50KYB1. 5B	IPEX-1.37 IPEX-1.13

面板连接器



TNC (M) -50KF

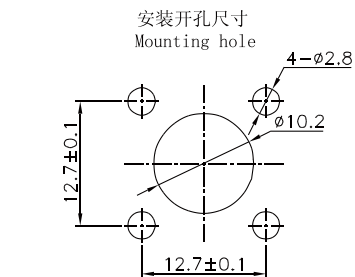
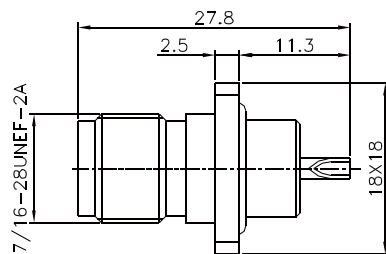

TNC系列射频同轴连接器



TNC-50KY

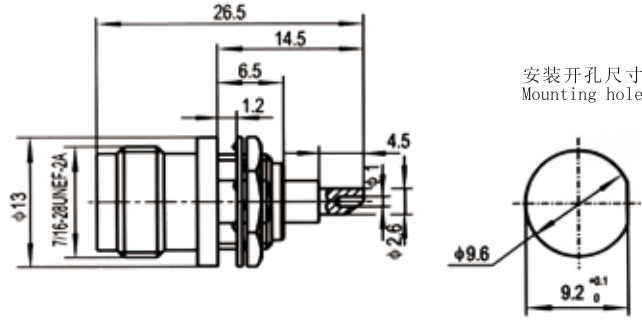

TNC-50KY-1

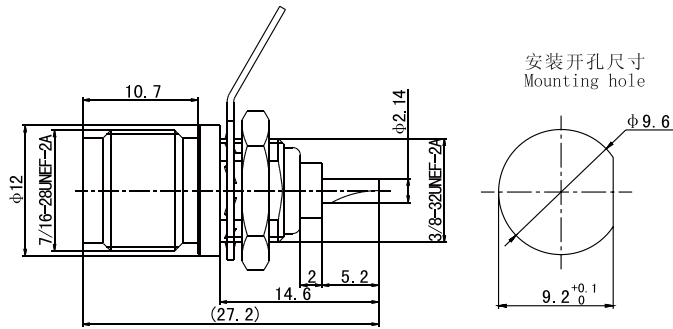

TNC (M) -50KY-3

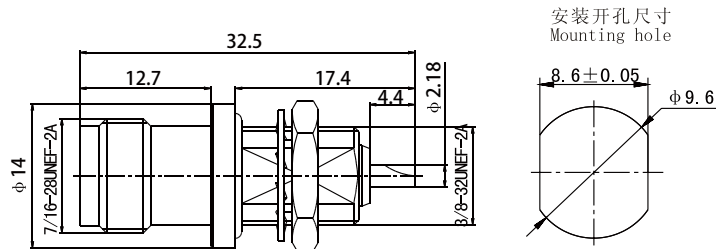

TNC (M) -50KYD1

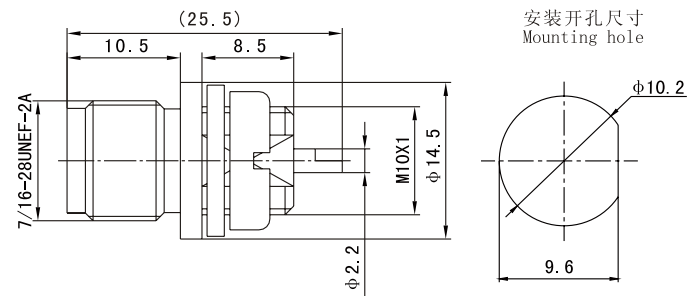

TNC系列射频同轴连接器



TNC (M) -50KYD2

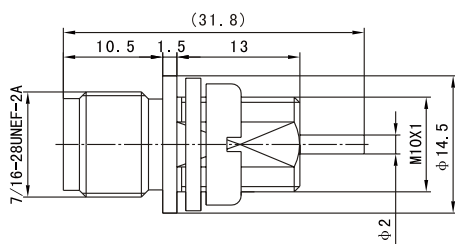

安装开孔尺寸
Mounting hole

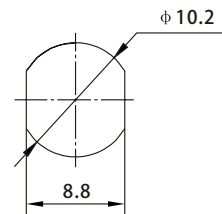

TNC-50KFD6

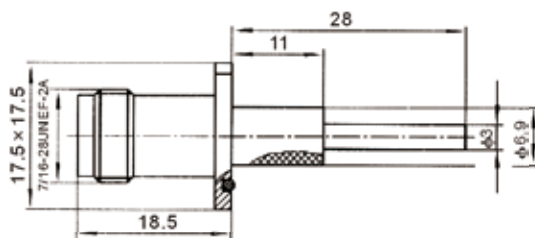

安装开孔尺寸
Mounting hole

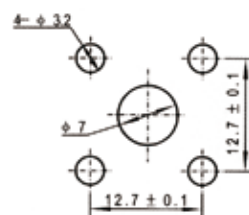

TNC-50KFD100

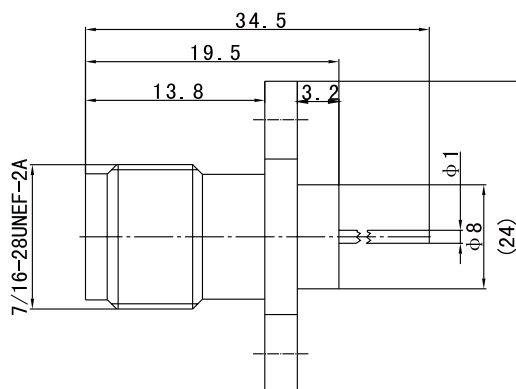

安装开孔尺寸
Mounting hole

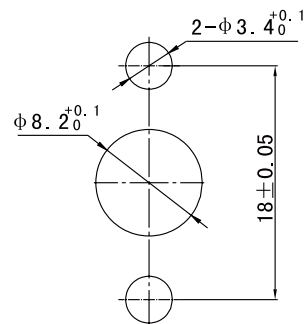

TNC-50KFD11

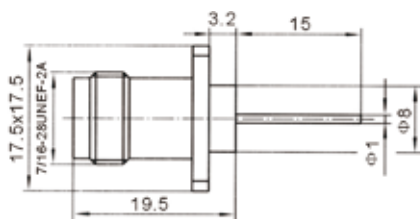

安装开孔尺寸
Mounting hole

