



# YL系列圆形连接器

## 概述

该系列产品符合GJB598A—1996系列I(等效于MIL-C-26482G系列I),其连接方式采用卡口连接,接触件端接形式为焊接或板接。产品具有快速连接和分离、体积小,密度高,耐环境好,可靠性高等特点。适用于航空航天、邮电通信、野战通信、卫星通信、舰船等电子设备的电气连接。该系列产品可与国内Y50EX系列产品互换。



## 型号命名

	YL	H	16	R	10	06	J	A	01	-W	-1	(Φ6)
主称代号												
接触件端接形式												
插头、插座类型												
壳体表面处理方式												
壳体号												
接触件孔位排列号												
接触件类型												
特殊接触件代号(无特殊件不标示)												
尾部附件代号												
绝缘安装板位置(N位不标示)												
特殊外壳件代号(无特殊件不标示)												
电缆直径												

序号	分类特征	标志代号	分类内容
1	主称代号	YL	圆形电连接器(符合GJB598A—1996系列I)
2	接触件端接形式	H	导线焊接
		B	印制板焊接
3	插头、插座类型	16/26	普通插头/屏蔽型
		14/24	螺母前安装插座/屏蔽型
		10/20	方形法兰盘安装插座/屏蔽型
		18/28	穿墙式螺母安装插座/屏蔽型
		19/29	穿墙式方形法兰盘安装插座/屏蔽型
		30/40	尾部有螺纹, 方形法兰盘安装插座/屏蔽型
		34/44	尾部有螺纹, 螺母安装插座/屏蔽型
		15/25	螺母后安装插座/屏蔽型
4	壳体表面处理方式	17/27	浮动插座/屏蔽型
		R	黑色阳极化(非导电外壳)
		W	砂绿色阳极化(非导电外壳)
		Wb	光亮绿色阳极化(非导电外壳)
		Wc	砂亚绿色阳极化(非导电外壳)
		N	化学镀暗镍(导电外壳)
		Nb	化学镀光亮镍(导电外壳)
		B	电镀镉(导电外壳)
		H	电镀黑铬(导电外壳)
		S	不锈钢钝化(导电外壳)
Y	灰色阳极化(非导电外壳)		

# YL系列圆形连接器



序号	分类特征	标志代号	分类内容
5	壳体号	数字	安装导向销钉的插座外圆直径的编号
6	接触件孔位排列号	数字(+字母)	接触件孔位排列代号
7	接触件类型	J	插针
		K	插孔
		S	穿墙插针, 用于螺母安装的穿墙插座, 面板外装孔, 面板内装孔
		S1	穿墙插针, 用于螺母安装的穿墙插座, 面板外装针, 面板内装孔
8	特殊接触件代号	A、B、C……	采用特殊接触件的流水号
9	尾部附件代号	01 <sup>#</sup> /21	直式电缆密封式/屏蔽型
		02/22/32	直式电缆夹线式/屏蔽型/密封屏蔽型
		03/23	橡胶尾罩密封式/屏蔽型
		04/24	弯式电缆防转密封式/屏蔽型
		05/25	弯式电缆夹线式/屏蔽型
		……	渐增的其它型式
10	绝缘安装板位置	W、X、Y、Z	绝缘体安装板与壳体主键的相对位置
11	特殊外壳件代号	1、2、3……	采用特殊外壳件的流水号
12	电缆直径	(Φ数字)	电缆直径大小

说明：“壳体号”为08和10时，直式电缆密封式尾部附件标志代号为“11”。

## 主要技术指标

### 【环境性能】

- 工作温度：-55℃ ~ +125℃
- 相对湿度：90% ~ 95% (40±2℃)
- 工作气压：4.39KPa ~ 101.33KPa
- 盐雾：5%NaCl雾中48h(N类)；96h (H类、R类、B类、S类)
- 密封性：
  - 插座：压差 $1.01 \times 10^5$ Pa, 历时1min无气泡漏泄
  - 头座插合：1m水深2h不渗水
- 振动：10~2000Hz,  $196\text{m/s}^2$ , 瞬断 $\leq 1\mu\text{s}$
- 冲击：980 $\text{m/s}^2$ , 瞬断 $\leq 1\mu\text{s}$
- 机械寿命：500次
- 绝缘电阻：

常态下(MΩ)	高温(MΩ)	潮湿(MΩ)
3000	500	100

### ——工作电流与接触电阻：

接触件代号	接触件配合直径 mm	接触电阻 mΩ	工作电流 A	电缆线芯最大直径mm
22D	Φ0.76	12.50	3.0	Φ0.644
22	Φ0.80	12.50	3.0	Φ0.644
20	Φ1.02	5.00	7.5	Φ0.812
16	Φ1.59	3.00	13.0	Φ1.291
	Φ1.50	3.00	13.0	Φ1.291
12	Φ2.00	2.00	20.0	Φ1.628
	Φ2.39	2.00	25.0	Φ2.053
10	Φ3.18	1.00	40.0	Φ2.588

### ——工作电压和耐电压：

工作等级*	工作电压 (V)			试验电压 (V)		
	使用等级 I	使用等级 II	使用等级 III	使用等级 I	使用等级 II	使用等级 III
海平面	600	1000	400	1500	2300	1300
21336m	300	450	200	375	500	250

注：0809工作电压为400V，试验电压为1000V。



# YL系列圆形连接器

绝缘体接触件孔位排列 (从插合面看插针绝缘体孔位)

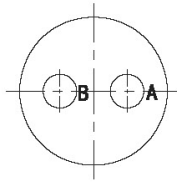

YL-0602  
(2- $\phi$ 1.02)

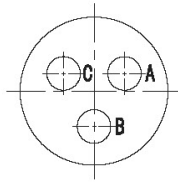

YL-0603  
(3- $\phi$ 1.02)

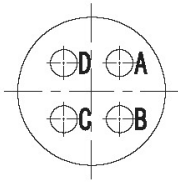

YL-0604  
(4- $\phi$ 0.76)

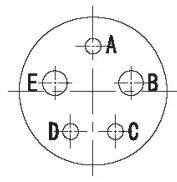

YL-0605  
(2- $\phi$ 1.02, 3- $\phi$ 0.76)

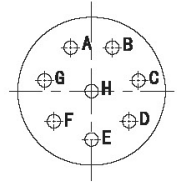

YL-0608  
(8- $\phi$ 0.6)

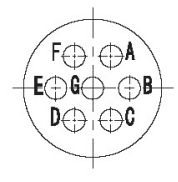

YL-0607  
(7- $\phi$ 0.76)

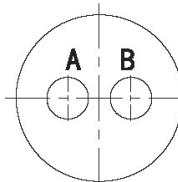

YL-0802  
(2- $\phi$ 1.5)

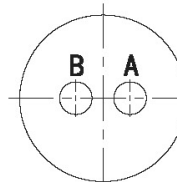

YL-0802a  
(2- $\phi$ 1.02)

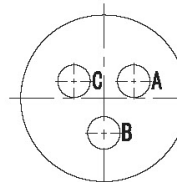

YL-0803  
(3- $\phi$ 1.02)

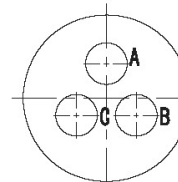

YL-0803a  
(3- $\phi$ 1.5)

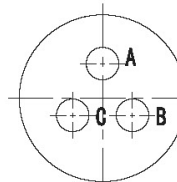

YL-0833  
(3- $\phi$ 1.02)

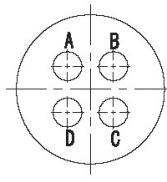

YL-0804  
(4- $\phi$ 1.02)

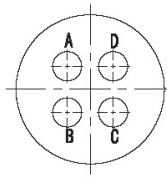

YL-0804b  
(4- $\phi$ 1.02)

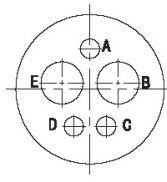

YL-0805  
(2- $\phi$ 2, 3- $\phi$ 0.76)

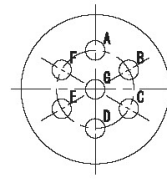

YL-0807  
(7- $\phi$ 0.8)

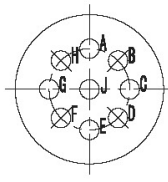

YL-0809  
(9- $\phi$ 0.76)

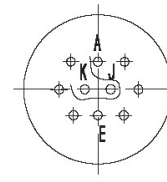

YL-0810  
(10- $\phi$ 0.6)

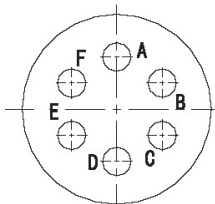

YL-1006  
(6- $\phi$ 1.02)

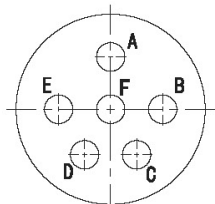

YL-1098  
(6- $\phi$ 1.02)

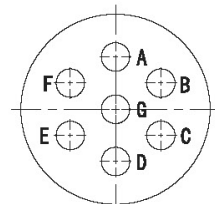

YL-1007(E)  
(7- $\phi$ 1.02)

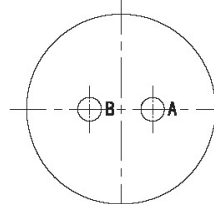

YL-1002  
(2- $\phi$ 1.02)

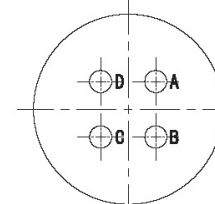

YL-1004  
(4- $\phi$ 1.02)

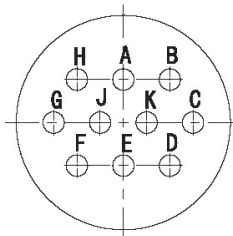

YL-1010  
(10- $\phi$ 0.8)

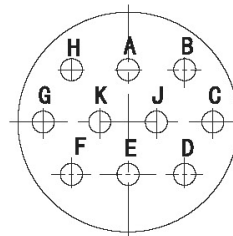

YL-1010a  
(10- $\phi$ 0.8)

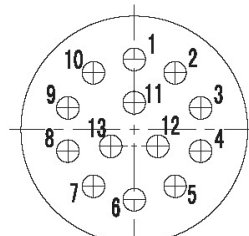

YL-1013  
(13- $\phi$ 0.8)

# YL系列圆形连接器

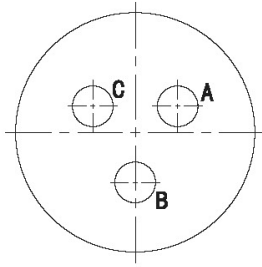

YL-1203a  
(3- $\phi$ 1.59)

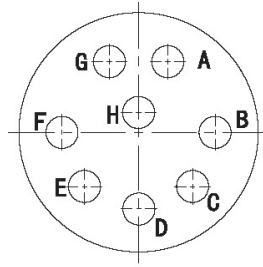

YL-1208  
(8- $\phi$ 1.02)

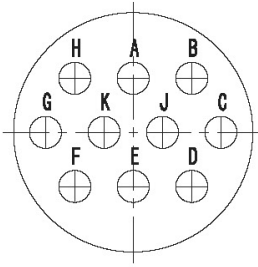

YL-1210  
(10- $\phi$ 1.02)

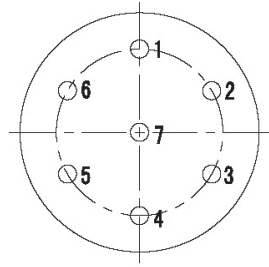

YL-1207  
(7- $\phi$ 1.02)

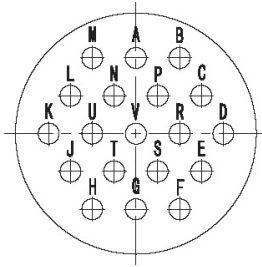

YL-1219  
(19- $\phi$ 0.8)

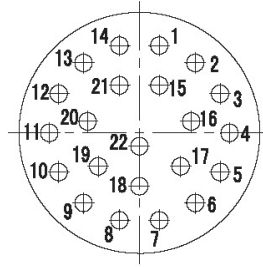

YL-1222  
(22- $\phi$ 0.76)

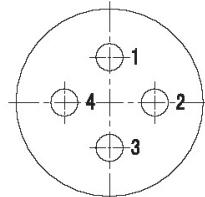

YL-1404  
(4- $\phi$ 2)

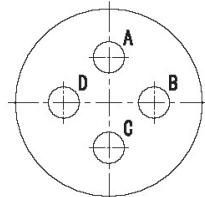

YL-1404a  
(4- $\phi$ 2.39)

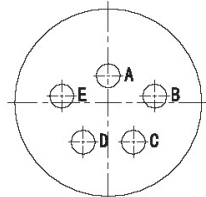

YL-1405  
(5- $\phi$ 1.59)

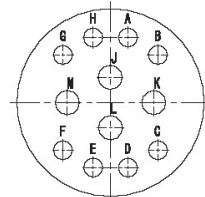

YL-1412  
(4- $\phi$ 1.59, 8- $\phi$ 1.02)

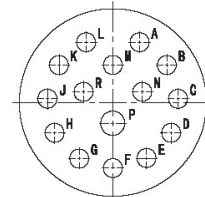

YL-1415  
(1- $\phi$ 1.59, 14- $\phi$ 1.02)

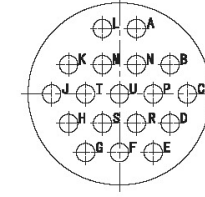

YL-1418  
(18- $\phi$ 1.02)

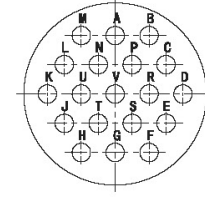

YL-1419  
(19- $\phi$ 1.02)

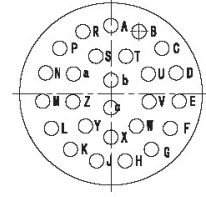

YL-1426  
(26- $\phi$ 0.8)

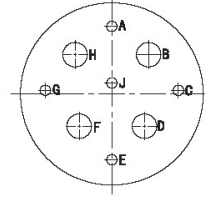

YL-1409  
(5- $\phi$ 1.02, 4- $\phi$ 2.39)

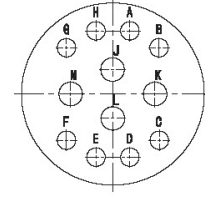

YL-1412a  
(4- $\phi$ 1.5, 8- $\phi$ 1.02)

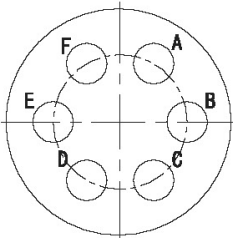

YL-1606  
(6- $\phi$ 3.18)

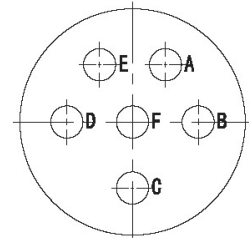

YL-1606a  
(6- $\phi$ 2.39)

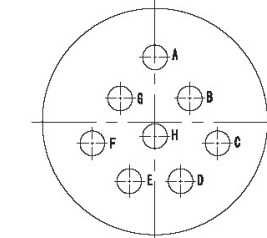

YL-1608  
(8- $\phi$ 1.59)

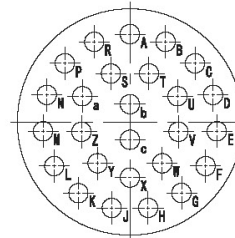

YL-1626  
(26- $\phi$ 1.02)



# YL系列圆形连接器

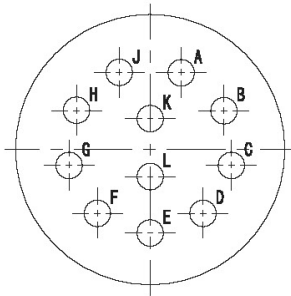

YL-1811  
(11- $\phi$ 1.59)

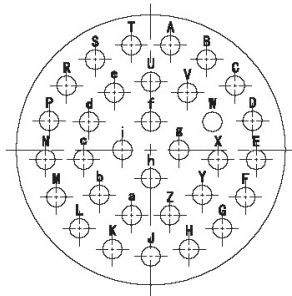

YL-1832  
(32- $\phi$ 1.02)

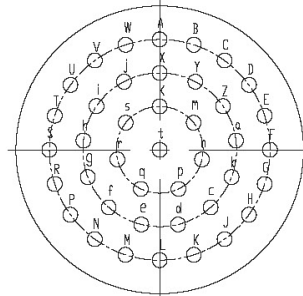

YL-1841  
(41- $\phi$ 0.8)

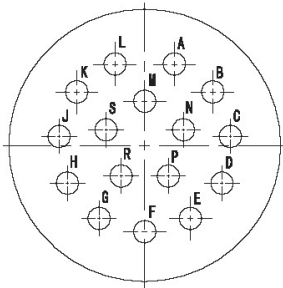

YL-2016  
(16- $\phi$ 1.59)

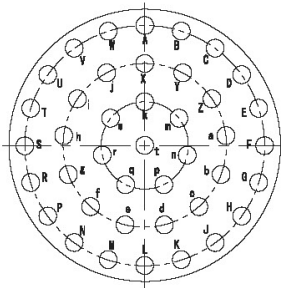

YL-2041  
(41- $\phi$ 1.02)

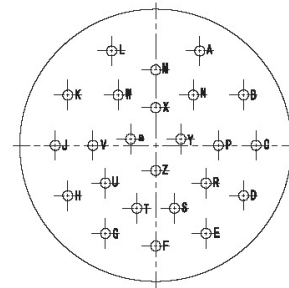

YL-2024  
(24- $\phi$ 1.02)

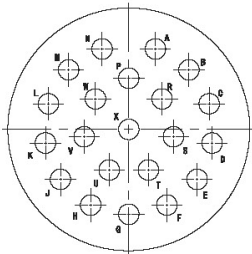

YL-2221  
(21- $\phi$ 1.59)

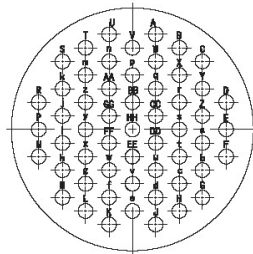

YL-2255  
(55- $\phi$ 1.02)

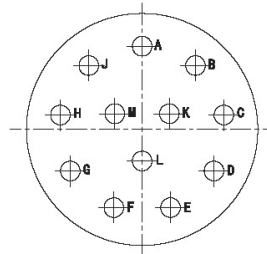

YL-2212  
(12- $\phi$ 2.39)

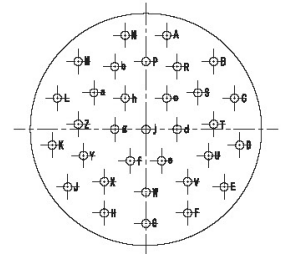

YL-2232  
(32- $\phi$ 1.02)

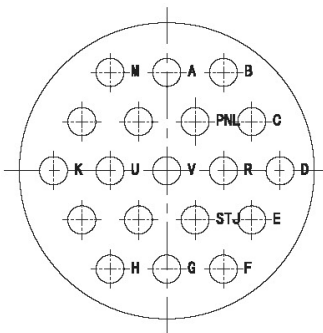

YL-2419  
(19- $\phi$ 2.39)

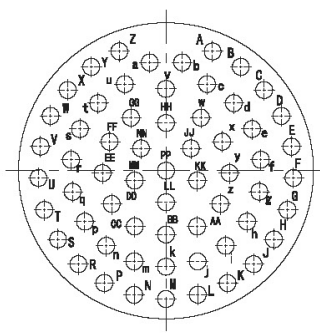

YL-2461  
(61- $\phi$ 1.02)

# YL系列圆形连接器



绝缘安装板位置（从插合面看插针绝缘体）

壳体号	接触件数目	绝缘安装板转角位置(N=0)				使用等级 I (耐压1500V)	使用等级 II (耐压2300V)	使用等级 III (耐压1300V)
		W	X	Y	Z			
06	02	—	—	—	—	✓	—	—
	03	—	—	—	—	✓	—	—
	04	—	—	—	—	—	—	✓
	07	—	—	—	—	—	—	✓
	08	—	—	—	—	—	—	—
08	02	—	—	—	—	✓	—	—
	02a	58°	122°	—	—	✓	—	—
	03	—	—	—	—	✓	—	—
	03a	—	—	—	—	✓	—	—
	33	90°	—	—	—	✓	—	—
	04	45°	—	—	—	✓	—	—
	04b	45°	—	—	—	✓	—	—
	05	—	—	—	—	—	—	✓
	07	90°	—	—	—	—	—	✓
09	—	—	—	—	—	—	✓	
10	06	90°	—	—	—	✓	—	—
	98	90°	180°	240°	270°	✓	—	—
	10	—	—	—	—	—	—	✓
	10a	—	—	—	—	—	—	✓
	13	—	—	—	—	—	—	✓
12	03a	—	—	180°	—	—	✓	—
	08	90°	112°	203°	292°	✓	—	—
	10	60°	155°	270°	295°	✓	—	—
	19	—	—	—	—	—	—	✓
	22	—	—	—	—	—	—	✓
14	04	—	—	—	—	—	✓	—
	04a	45°	—	—	—	—	✓	—
	05	40°	92°	184°	273°	—	✓	—
	12	43°	90°	—	—	✓	—	—
	15	17°	110°	155°	234°	✓	—	—
	18	15°	90°	180°	270°	✓	—	—
	19	30°	165°	315°	—	✓	—	—
	26	—	—	—	—	—	—	✓
16	06	—	—	—	—	—	✓	—
	06a	—	—	—	—	—	✓	—
	08	54°	152°	180°	331°	—	✓	—
	26	60°	—	275°	338°	✓	—	—
18	11	62°	119°	241°	340°	—	✓	—
	32	85°	138°	222°	265°	✓	—	—
	41	—	—	—	—	—	—	✓
20	16	238°	318°	333°	347°	—	✓	—
	41	45°	126°	225°	—	✓	—	—
22	21	16°	135°	175°	349°	—	✓	—
	55	30°	142°	226°	314°	✓	—	—
24	61	90°	180°	270°	324°	✓	—	—



# YL系列圆形连接器

## 外形尺寸及安装尺寸

### 1. 插头

壳体号	A	M	L(参考)
06	15.5	M10×0.75(左)	22
08	20	M14×1.0(左)	22
10	22.4	M16×1.0(左)	22.2
12	26.5	M20×1.0(左)	22.5
14	31	M24×1.0(左)	24.6
16	32	M24×1.0(左)	24.5
18	35	M27×1.0(左)	23
20	40	M32×1.0(左)	26
22	42.2	M33×1.0(左)	26
24	47.6	M36×1.0(左)	25.1

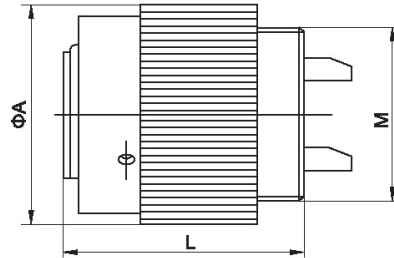

### 2. 法兰安装插座外形尺寸及安装开孔尺寸

#### 1) 方形法兰盘安装导线焊接插座

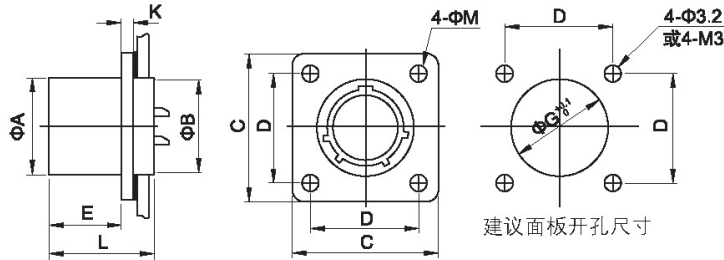

#### 2) 方型法兰盘安装印制板焊接插座

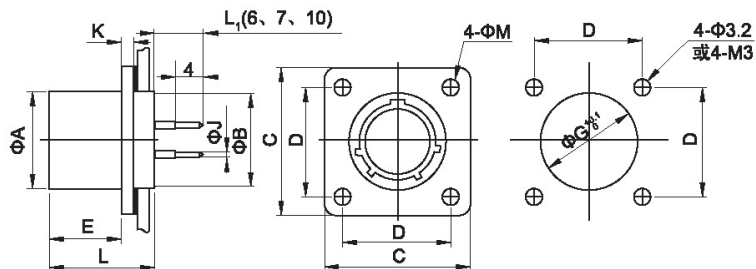
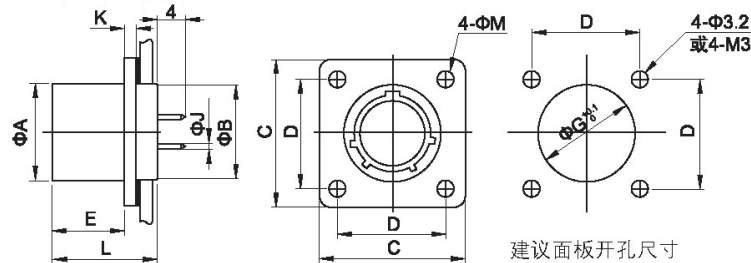

接触件代号	J	L1
22	0.8	6、7、10
22D	0.8	6、7、10
20	1	6、7、10
16	1	6、7、10

#### 3) 方型法兰盘安装插座外形尺寸及安装开孔尺寸表

壳体号	A	B	C	D	E	G	K	M	L(参考)
06	10.6	10.6	19	13	14.5	11	1.5	3.2	20
08	12	12	21	15	14.5	12.5	1.5		20
10	15	15	24	18	14.5	15.5	1.5	3.6	21
12	19	19	27	21	14.5	19.5	1.5		21
14	22.2	22.2	28.6	23	14.5	23	1.9		21
16	25.4	25.4	31.3	24.6	14.5	26	1.5		21
18	28.6	28.6	36	27	14.5	30	1.5		24
20	31.7	31.7	36.9	29.36	14.5	32.5	2.5		26.5
22	34.9	34.9	40	32	14.5	35.5	2.5		26.5
24	38.1	38.1	42.9	34.9	14.5	39	2.2		26.5

# YL系列圆形连接器



## 3. 螺母安装电连接器插座

### 1) 螺母安装导线焊接插座

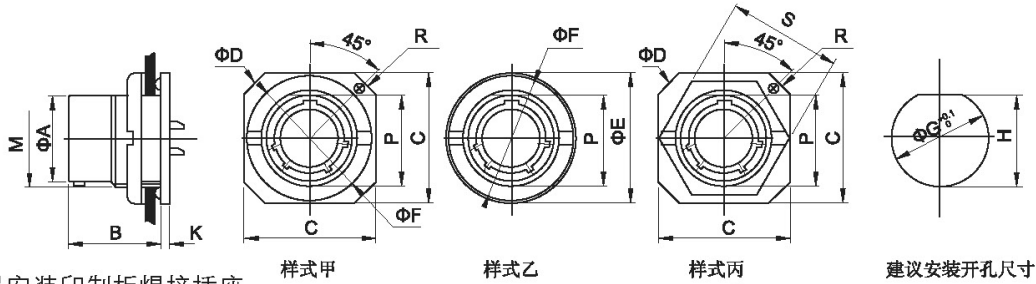

### 2) 螺母安装印制板焊接插座

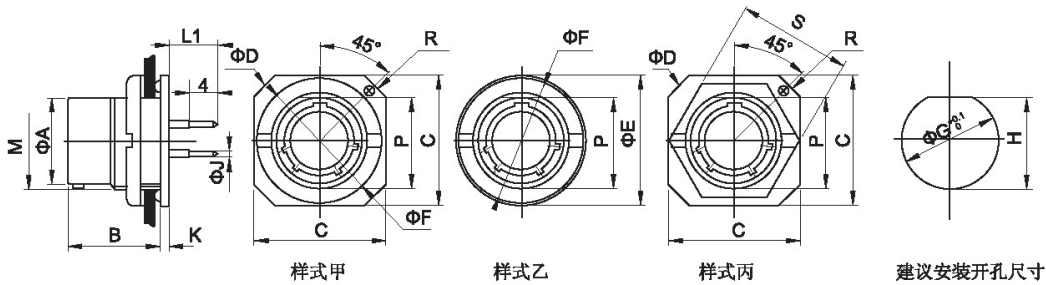
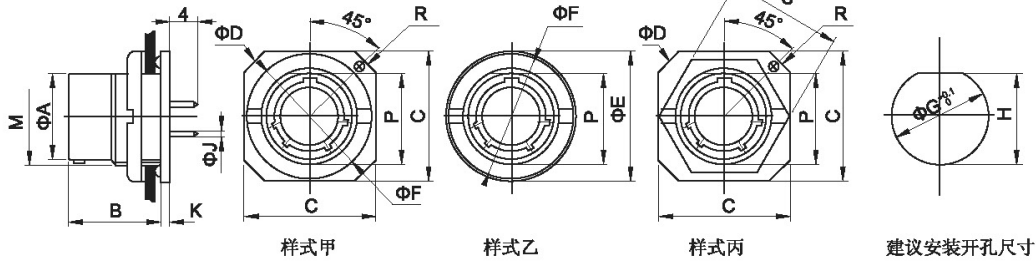

接触件代号	J	L1
22	0.8	6、7、10
22D	0.8	6、7、10
20	1	6、7、10
16	1	6、7、10

注：紧定螺钉必须拧紧，并粘胶固定以防脱落。  
如不用请将紧定螺钉拆除。

### 3) 螺母安装插座外形尺寸及安装开孔尺寸表

壳体号	A	B	C	R	E	P	K	F	S	G	H	M	常规样式
06	10.6	17.5	17	—	17	11.3	2.5	17	17	12.2	11.4	M12×1	样式乙
08	12	17.5	19	10.25	19	13	2.5	18	19.4	14.2	13.2	M14×1	样式乙
10	15	18.5	25	13.5	23.5	16.9	2.5	21.7	21.7	18.2	17.2	M18×1	样式甲
12	19	18.5	32	15.5	30	20.7	2.5	26.5	27	22.2	21.0	M22×1	样式丙
14	22.2	18.5	35	17.5	34.3	23.8	2.5	32	30	25.2	24.0	M25×1.5	样式丙
16	25.4	18.5	38.1	19	38	27.1	2.5	34	33	28.2	27.3	M28×1	样式丙
18	28.6	18.5	41.5	20.5	41	30.3	2.5	37	37	32.2	30.5	M32×1	样式丙
20	31.7	22.5	46	23.2	46	35	3	42	40	36.2	35.2	M36×1	样式丙
22	34.9	22.7	49	24	49	37	3.8	44	43	38.2	37.2	M38×1	样式丙
24	38.1	22.5	52	26	52	39.8	3	48	48	42.2	40.0	M42×1.5	样式丙

注：用户可按实际使用要求选用不同的样式；对印制板焊接插座，PCB开孔尺寸以我公司传真为依据。





# YL系列圆形连接器

## 4) 穿墙式法兰盘安装电连接器插座

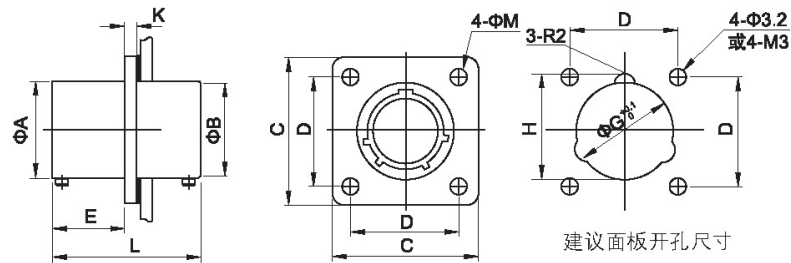

壳体号	A	B	C	D	E	G	H	K	M	L(参考)
06	10.6	10.6	19	13	16.5	11	13	2	3.2	35
08	12	12	21	15		12.5	14.5			
10	15	15	24	18		15.5	17.5			
12	19	19	27	21		19.5	21.5			
14	22.2	22.2	28.6	23		23	25			
16	25.4	25.4	31.3	24.6		26	28			
18	28.6	28.6	36	27		30	32	2.5	3.6	
20	31.7	31.7	36.9	29.36		32.5	34.5			
22	34.9	34.9	40	32		35.5	37.5	35.5		
24	38.1	38.1	42.9	34.9		39	41			

## 5) 穿墙式螺母安装电连接器插座

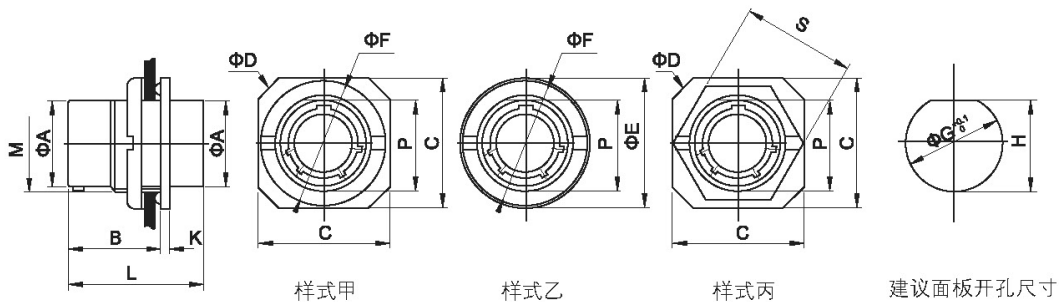

壳体号	A	B	C	D	E	P	L	K	F	S	G	H	M	常规样式		
06	10.6	17.5	17	20	17	11.3	35	2.5	17	17	12.2	11.4	M12×1	样式乙		
08	12	17.5	19	22	19	13			18	19.4	14.2	13.2	M14×1	样式乙		
10	15	18.5	25	30.8	23.5	16.9			21.7	21.7	18.2	17.2	M18×1	样式甲		
12	19	18.5	32	34.5	30	20.7			25	27	22.2	21.0	M22×1	样式丙		
14	22.2	18.5	35	40	34.3	23.8			32	30	25.2	24.0	M25×1.5	样式丙		
16	25.4	18.5	38.1	42	38	27.1			34	33	28.2	27.3	M28×1	样式丙		
18	28.6	18.5	41.5	46.5	41	30.3			37	37	32.2	30.5	M32×1	样式丙		
20	31.7	22.5	46	50.2	46	35			35.5	3	42	40	36.2	35.2	M36×1	样式丙
22	34.9	22.5	49	52.2	49	37					44	43	38.2	37.2	M38×1	样式丙
24	38.1	22.5	52	56	52	39.8					48	48	42.2	40.0	M42×1.5	样式丙

注：用户可按实际使用要求选用不同的样式。

# YL系列圆形连接器



## 6. 附件

### 6.1 尾部附件

#### 1) 直式电缆密封式尾部附件

壳体号	A	电缆直径	L(参考)
06	14.5	5	26
		6	
08	18.5	5	33
		6	
		7	
10	20.5	5	35
		6	
		7	
		8	
12	23	7	38
		8	
		9	
		10	
14、16	26.5	8	42
		9	
		10	
		11	
		12	
18	32	10	42
		12	
		13	
		15	
20	35.5	11	42
		12	
		13	
		15	
22	39	13	52
		15	
		17	
24	40	13	58
		15	
		17	

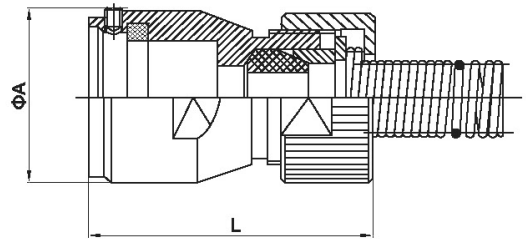

#### 型号示例

	YL	-12	N	-01	-5
基本元件号					
壳体号					
壳体表面处理方式					
尾部附件代号					
电缆直径					

注：当壳体号为08、10时，尾部附件代号为“11”；其它壳体号为“01”。

#### 2) 直式屏蔽电缆密封式尾部附件

壳体号	A	电缆直径	L(参考)
06	14.5	5	28
		6	
08	19	5	40
		6	
		7	
10	20.5	5	41
		6	
		7	
		8	
12	24	7	42
		8	
		9	
		10	

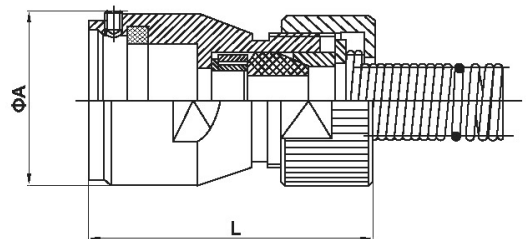



# YL系列圆形连接器

壳体号	A	电缆直径	L(参考)
14、16	28	8	43
		9	
		10	
		11	
		12	
18	32	10	43
		12	
		13	
		15	
20	35.5	11	44
		12	
		13	
		15	
22	39	13	57
		15	
		17	
24	39	13	58
		15	
		17	

型号示例

	YL	-08	N	-21	-5
基本元件号					
壳体号					
壳体表面处理方式					
尾部附件代号					
电缆直径					

### 3) 直式电缆夹线式尾部附件

壳体号	A	电缆直径	L(参考)
06	14.5	5	22
		6	
08	18.5	5	22
		6	
		7	
10	20.5	5	22
		6	
		7	
		8	
12	22.6	7	22
		8	
		9	
		10	
14、16	27	8	23
		9	
		10	
		11	
		12	
18	31	10	32
		12	
		13	
		15	
20	35.5	11	32
		12	
		13	
		15	
22	38	13	42
		15	
		17	
24	40.5	13	42
		15	
		17	

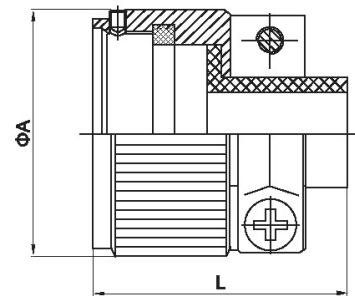

型号示例

	YL	-08	N	-02	-5
基本元件号					
壳体号					
壳体表面处理方式					
尾部附件代号					
电缆直径					

# YL系列圆形连接器



## 4) 直式屏蔽电缆夹线式尾部附件

壳体号	A	电缆直径	L(参考)
06	14.5	5	31
		6	
08	20	5	42
		6	
		7	
10	20	5	42
		6	
		7	
		8	
12	24	7	42
		8	
		9	
		10	
14、16	30	8	40
		9	
		10	
		11	
		12	
18	32	10	42
		12	
		13	
		15	
20	35.5	11	44
		12	
		13	
		15	
22	39	13	51
		15	
24	39	17	53
		13	
		15	

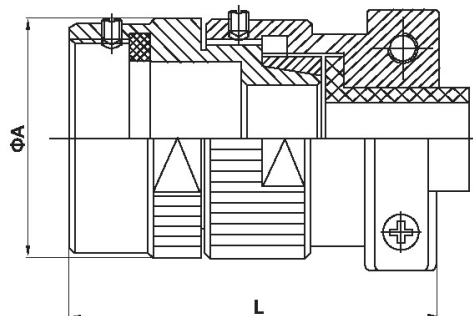

型号示例

基本元件号	YL	-08	N	-22	-5
壳体号					
壳体表面处理方式					
尾部附件代号					
电缆直径					

## 5) 直式屏蔽电缆夹线式尾部附件

壳体号	A	电缆直径	L(参考)
06	14.5	5	31
		6	
08	20	5	40
		6	
		7	
10	20.5	5	41
		6	
		7	
		8	
12	24	7	45
		8	
		9	
		10	

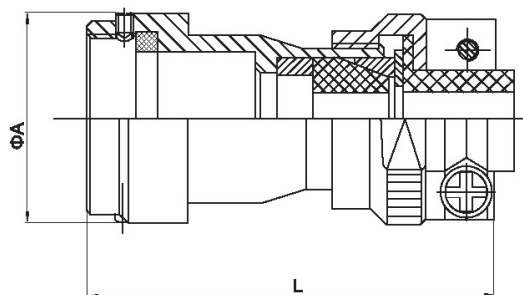



# YL系列圆形连接器

壳体号	A	电缆直径	L(参考)
14、16	28	8	45
		9	
		10	
		11	
		12	
18	32	10	45
		12	
		13	
		15	
20	35.5	11	52
		12	
		13	
		15	
22	39	13	55
		15	
		17	
24	39	13	55
		15	
		17	

型号示例

	YL	-08	N	-32	-5
基本元件号					
壳体号					
壳体表面处理方式					
尾部附件代号					
电缆直径					

## 6) 橡胶尾罩密封式尾部附件

壳体号	A	电缆直径	L(参考)
06	12.5	5	34
		6	
08	18.5	5	40
		6	
		7	
10	20.5	5	41
		6	
		7	
		8	
12	25.5	7	42
		8	
		9	
		10	
14、16	30.5	8	48
		9	
		10	
		11	
		12	
18	34	10	65
		12	
		13	
		15	
20	39.5	11	70
		12	
		13	
		15	
22	39	13	70
		15	
		17	
24	39	13	70
		15	
		17	

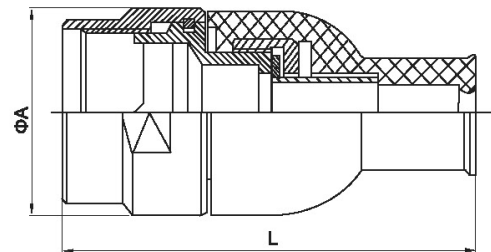

型号示例

	YL	-08	N	-03	-5
基本元件号					
壳体号					
壳体表面处理方式					
尾部附件代号					
电缆直径					

# YL系列圆形连接器



## 7) 屏蔽型橡胶尾罩密封式尾部附件

壳体号	A	电缆直径	L(参考)
06	14,5	5	55
		6	
08	19,5	5	57
		6	
		7	
10	22	5	58
		6	
		7	
		8	
12	26	7	62
		8	
		9	
		10	
14、16	30,5	8	67
		9	
		10	
		11	
		12	
18	34	10	75
		12	
		13	
		15	
20	39,5	11	80
		12	
		13	
		15	
22	39	13	80
		15	
24	39	13	80
		15	
		17	

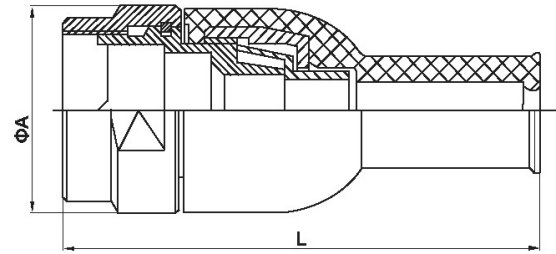

型号示例

基本元件号	YL	-08	N	-23	-5
壳体号					
壳体表面处理方式					
尾部附件代号					
电缆直径					

## 8) 弯式电缆尾部附件

壳体号	A	电缆直径	L(参考)
06	14,5	5	28
		6	
08	18	5	28
		6	
		7	
10	20,5	5	28
		6	
		7	
		8	
12	24	7	35
		8	
		9	
		10	

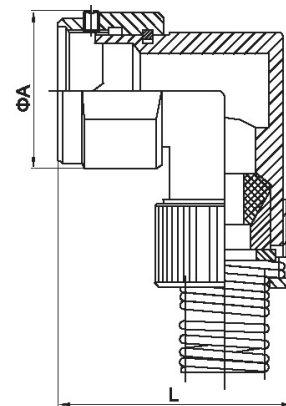



# YL系列圆形连接器

壳体号	A	电缆直径	L(参考)
14、16	29	8	48
		9	
		10	
		11	
		12	
18	31	10	48
		12	
		13	
		15	
20	35.5	11	55
		12	
		13	
		15	
22	39	13	55
		15	
		17	
24	39	13	65
		15	
		17	

型号示例

	YL	-08	N	-04	-5
基本元件号					
壳体号					
壳体表面处理方式					
尾部附件代号					
电缆直径					

## 9) 橡胶尾罩密封式尾部附件

壳体号	A	电缆直径	L(参考)
06	14.5	5	30
		6	
08	19	5	33
		6	
		7	
10	20.5	5	35
		6	
		7	
		8	
12	24	7	48
		8	
		9	
		10	
14、16	28	8	48
		9	
		10	
		11	
		12	
18	32	10	48
		12	
		13	
		15	
20	35.5	11	55
		12	
		13	
		15	
22	39	13	55
		15	
		17	
24	39	13	65
		15	
		17	

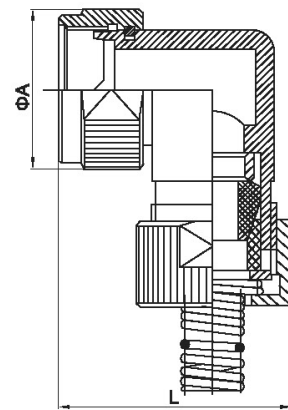

型号示例

	YL	-08	N	-24	-5
基本元件号					
壳体号					
壳体表面处理方式					
尾部附件代号					
电缆直径					

# YL系列圆形连接器



## 10) 弯式电缆夹线式尾部附件

壳体号	A	电缆直径	L(参考)
06	14.5	5	30
		6	
08	19	5	30
		6	
		7	
10	20.5	5	35
		6	
		7	
		8	
12	24	7	38
		8	
		9	
		10	
14、16	28	8	45
		9	
		10	
		11	
		12	
18	32	10	48
		12	
		13	
		15	
20	35.5	11	55
		12	
		13	
		15	
22	39	13	55
		15	
24	39	13	65
		15	
		17	

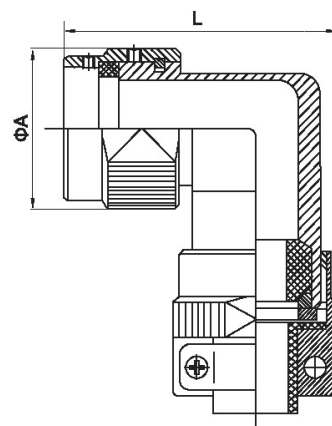

型号示例

基本元件号	YL	-08	N	-05	-5
壳体号					
壳体表面处理方式					
尾部附件代号					
电缆直径					

## 11) 弯式屏蔽电缆夹线式尾部附件

壳体号	A	电缆直径	L(参考)
06	14.5	5	38
		6	
08	19	5	40
		6	
		7	
10	20.5	5	41
		6	
		7	
		8	
12	24	7	42
		8	
		9	
		10	

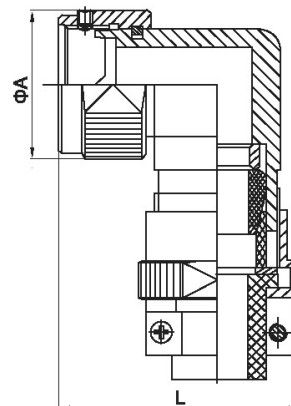





# YL系列圆形连接器

壳体号	A	电缆直径	L(参考)
14、16	28	8	45
		9	
		10	
		11	
		12	
18	32	10	48
		12	
		13	
		15	
20	35.5	11	55
		12	
		13	
		15	
22	39	13	57
		15	
		17	
24	39	13	65
		15	
		17	

型号示例

	YL	-08	N	-25	-5
基本元件号					
壳体号					
壳体表面处理方式					
尾部附件代号					
电缆直径					

注：尾部附件若与插头或插座的订购数量相同，可直接在型号后面加尾部附件代号，若与插头或插座的订购数量不同，则需单独订购。

## 6.2 金属防水盖

### a) 插头防水盖

壳体号	A	B	E	F	L(参考)
06	10.6	17	10	18.5	100mm
08	12	20			
10	15	22.2			
12	19	26		19	
14	22.2	29			
16	25.4	32			
18	28.6	34.5		18.5	
20	31.7	38.5			
22	35	41			
24	38	44	11	20	

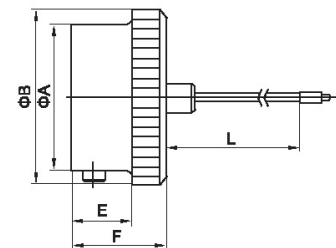

### b) 插座防水盖

壳体号	A	B	E	F	L(参考)
06	14	15.5	7.5	18.5	100mm
08	16.5	19	10		
10	20	22.4			
12	24	25			
14	27	30			
16	30	32			
18	33	35			
20	37	40			
22	39.8	43			
24	43.4	45.4			

#### (1) 方形法兰盘安装插座防水盖

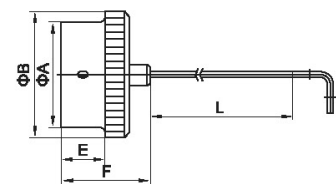

#### (2) 螺母安装插座防水盖

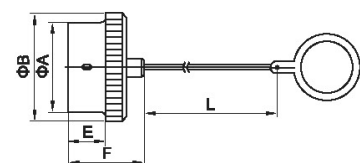

# YL系列圆形连接器



型号示例

	YL	-3181	-08	N	-L	-O
主称代号						
插头、插座类型:	3181插座防水盖		3180插头防水盖			
壳体号						
表面处理方式						
链子为金属链(用于插座)						
无L链子为尼龙绳						
法兰盘安装插座的防水盖						

注: 防水盖应单独订购。

## 6.3 橡胶防尘罩

### a) 插头防尘罩

壳体号	A	B	L(参考)
06	10	9.5	100mm
08	11	11	
10	14.5	11	
12	19.3	12	
14	20	12.5	
16	25	13	
18	28.7	13	
20	29.5	13	
22	34	14	
24	38	14	

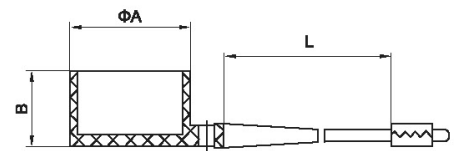

### b) 插座防尘罩

壳体号	A	B	L(参考)
06	15	9.5	100mm
08	14.5	11	
10	20	14.5	
12	24	12.5	
14	26	13	
16	29.5	13	
18	32.8	13	
20	36.2	14	
22	38	14	
24	43	14	

### (1) 方形法兰盘安装插座防尘罩

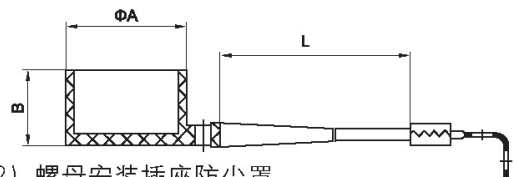

### (2) 螺母安装插座防尘罩

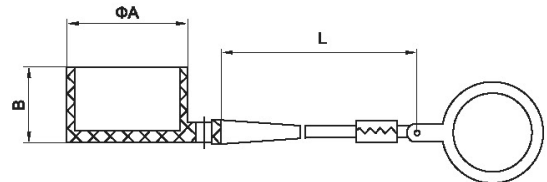

注: 防尘盖应单独订购。

型号示例

	YL	-3182	-08	-□	-O
主称代号					
橡胶类	3182插头防尘罩		3183插座防尘罩		
壳体号	06/08				
表示为序列号:	A/B/C.....				
法兰盘安装的防尘罩					